

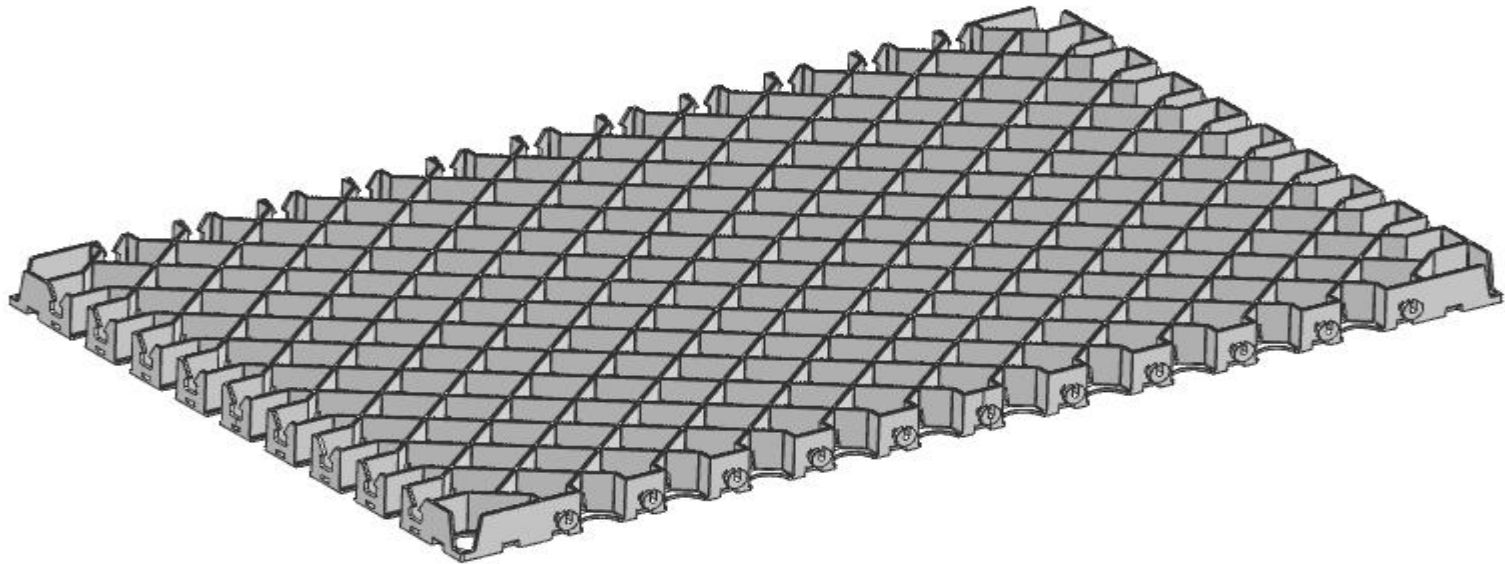

# Longxiang Group Ltd.



Our Grid(branded 123) was originally designed for using on farms for solving problems with muddy areas on their properties, everything from muddy cattle yards to muddy driveways. The solution was easy, stabilise the ground and develop a drainage system, better still, design one product that does both!



## Specification

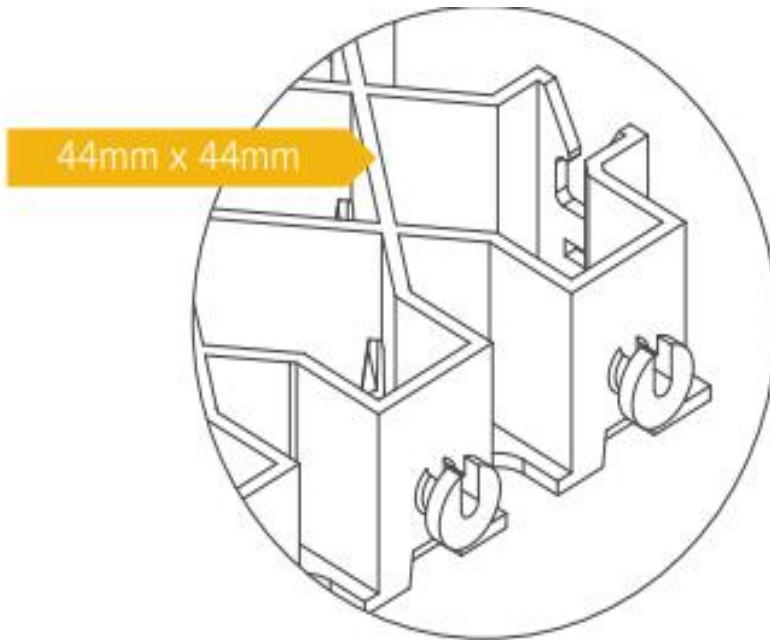

- ✓ UV stabilised
- ✓ Relocatable
- ✓ Do-It-Yourself
- ✓ Interlocking system

Measurements: 1000x1000x40mm and 500x500x40mm  
Crush resistance (filled with gravel/road base) 1000+ tonne m<sup>2</sup>\*  
Crush resistance (empty grid) : 280 tonne m<sup>2</sup>\*  
Weight per grid 5.6kg and 1.1kg  
Fill ratio per grid 1 cubic metre of fill per 25sqm  
Permeability Up to 96%  
Fill Road base, gravel, pebbles, grass, soil, concrete, bitumen

The grid size is 44x44mm,  
it can fit 5-15mm of the gravel,  
and our plastic grid is very strong,  
can load over 1000tons.



# Longxiang Group Ltd.

## 123 Grid Advantage

SURFACE CONSIDERATION	CONCRETE	CONCRETE SLABS / PAVERS	ASPHALT	123 GRID
LONGEVITY	15–20 years	10–15 years	5–10 years	30+ years
MATERIALS REQUIRED	Cement and steel mesh, formwork required	Cement slabs (pre-cast)	Asphalt mixture (tar and aggregate)	100% recycled polypropylene
MAINTENANCE	<b>Low</b> – Prone to cracking and becoming unlevelled	<b>Low</b> – Can become cracked and unlevelled	<b>High</b> – Ongoing maintenance, top seal every 2-3 years	<b>Very low</b> – May require gravel or grass maintenance
COST & APPEARANCE	Black, uniform, industrial, high cost	Options available at a higher cost	Uniform, options available at a higher cost	Variety of fills available at low cost to blend into natural environments
PERMEABILITY	N/A	15-30%	N/A	Up to 100%
DEPTH	Varies from 3–11” depending on application	Varies from 4–6” depending on application/loads	Average of 4–4.5”	Varies from 1–2”
ENVIRONMENTAL FRIENDLINESS	High impact, not recyclable or reusable, high ground runoff, ground suffocated, can generate acid	High impact, not recyclable or reusable, requires waste dump if removed, suffocates ground	High impact if dumped/removed – uses oil based derivatives, not recyclable or reusable, high ground runoff, ground suffocated	Low impact, uses recycled materials, can be moved, used or replaced, up to 100% permeability, low runoff, maintains breathability



Longxiang Group Ltd.

## Square and Circle Grid Compare

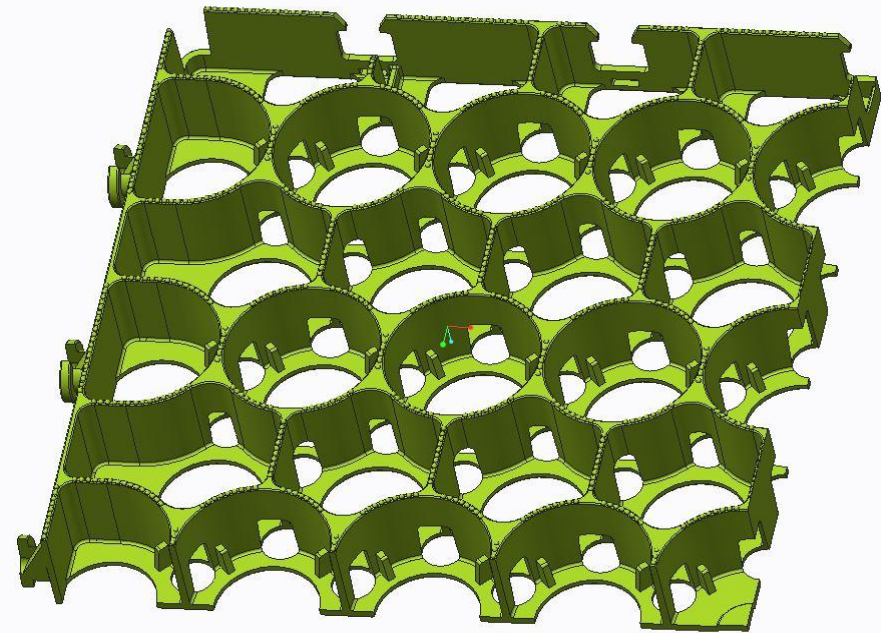
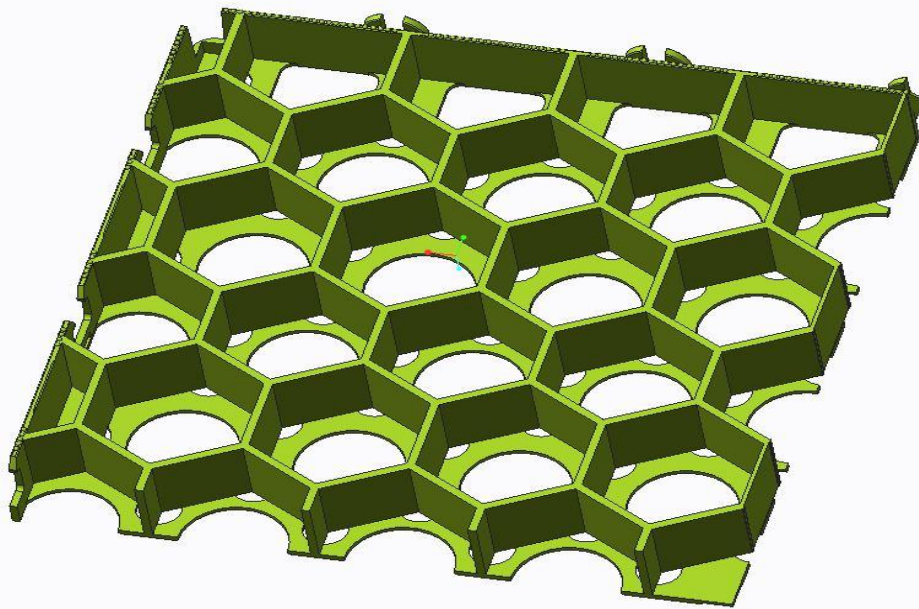

Circle pattern would easy creates thick wall sections, Hexagon reating a more even wall section, so Hexagon would stronger than the circle pattern.



Longxiang Group Ltd.

## Mold design

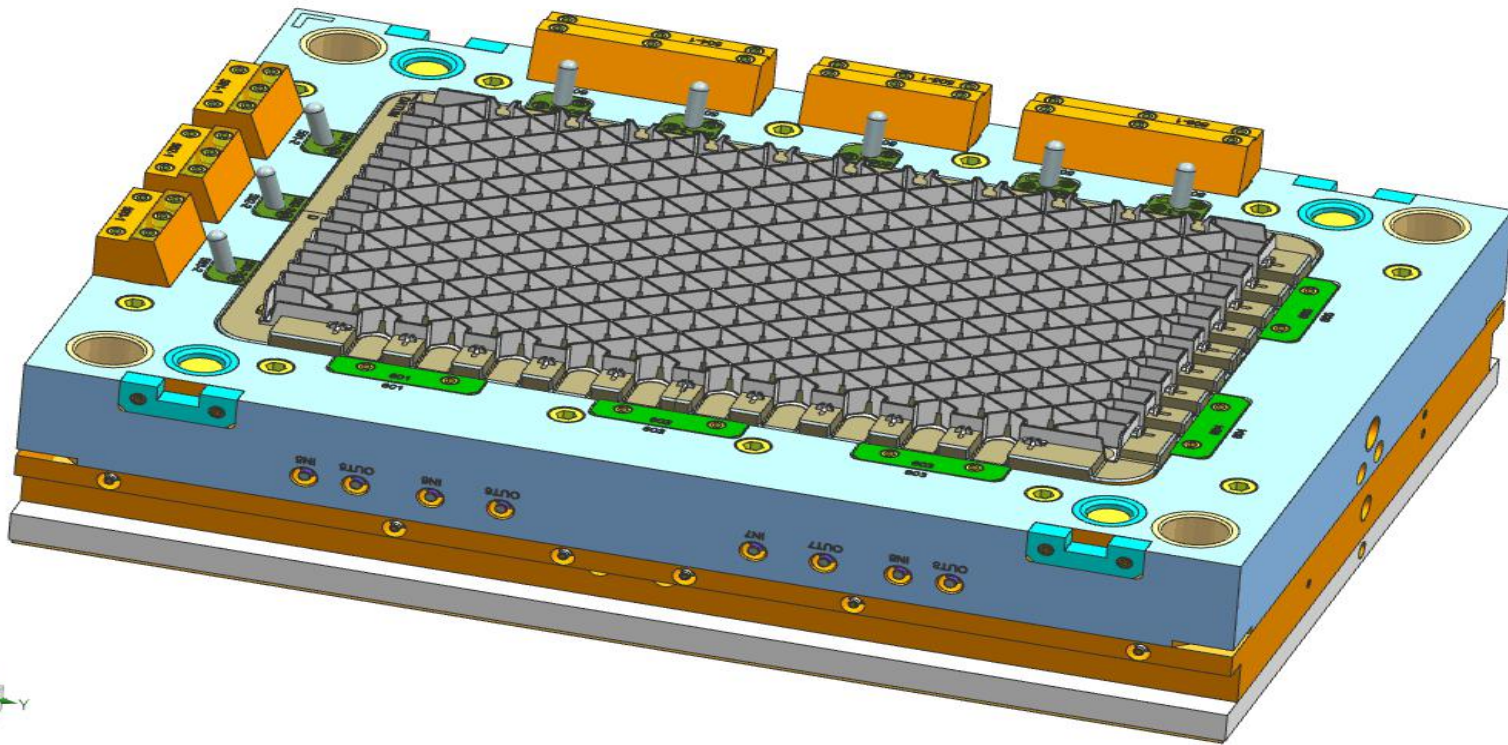

2018-03-28

123 Plastic Grids



Longxiang Group Ltd.

## Mold Making

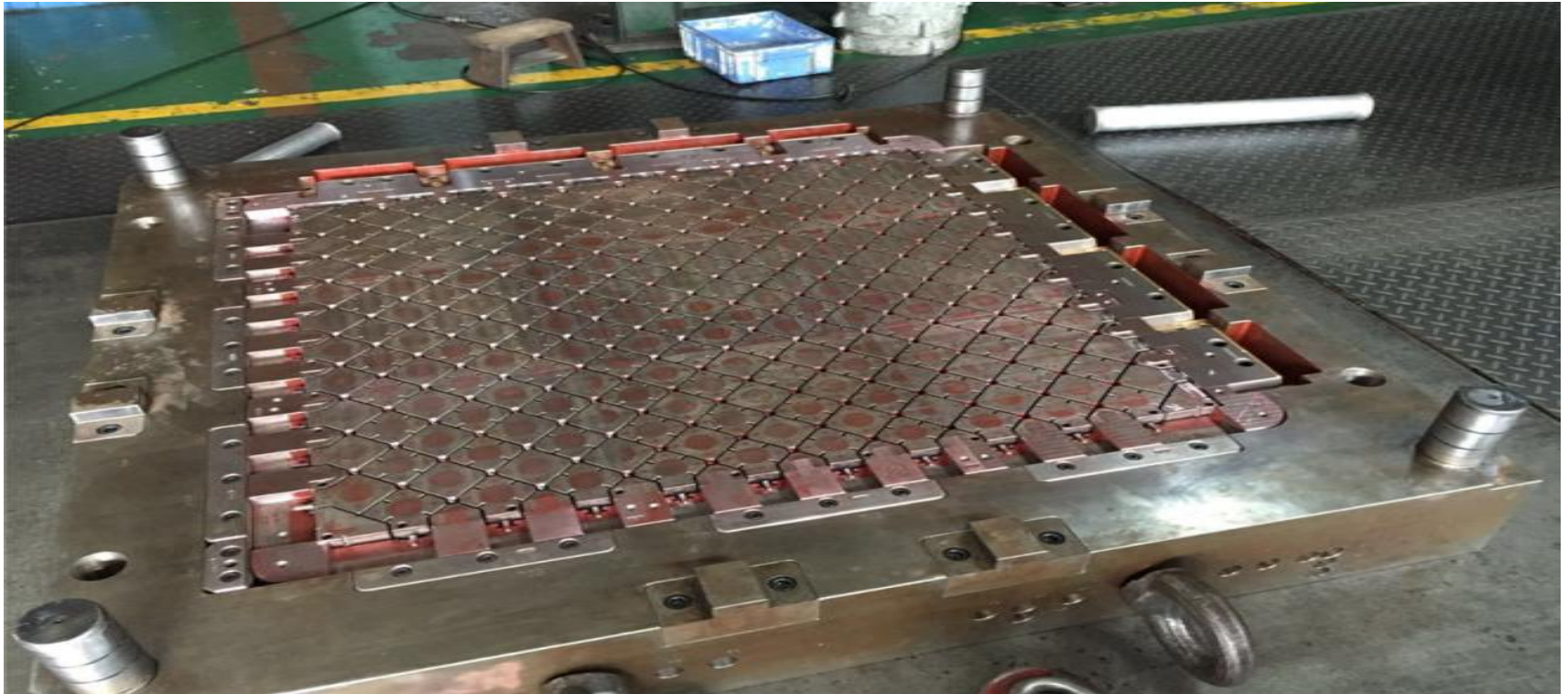

The toolings are made by us, we have the patent on the plastic grid, we not only sell the finished products, but also sell the moulds if have interesting.

2018-03-28

123 Plastic Grids



Longxiang Group Ltd.

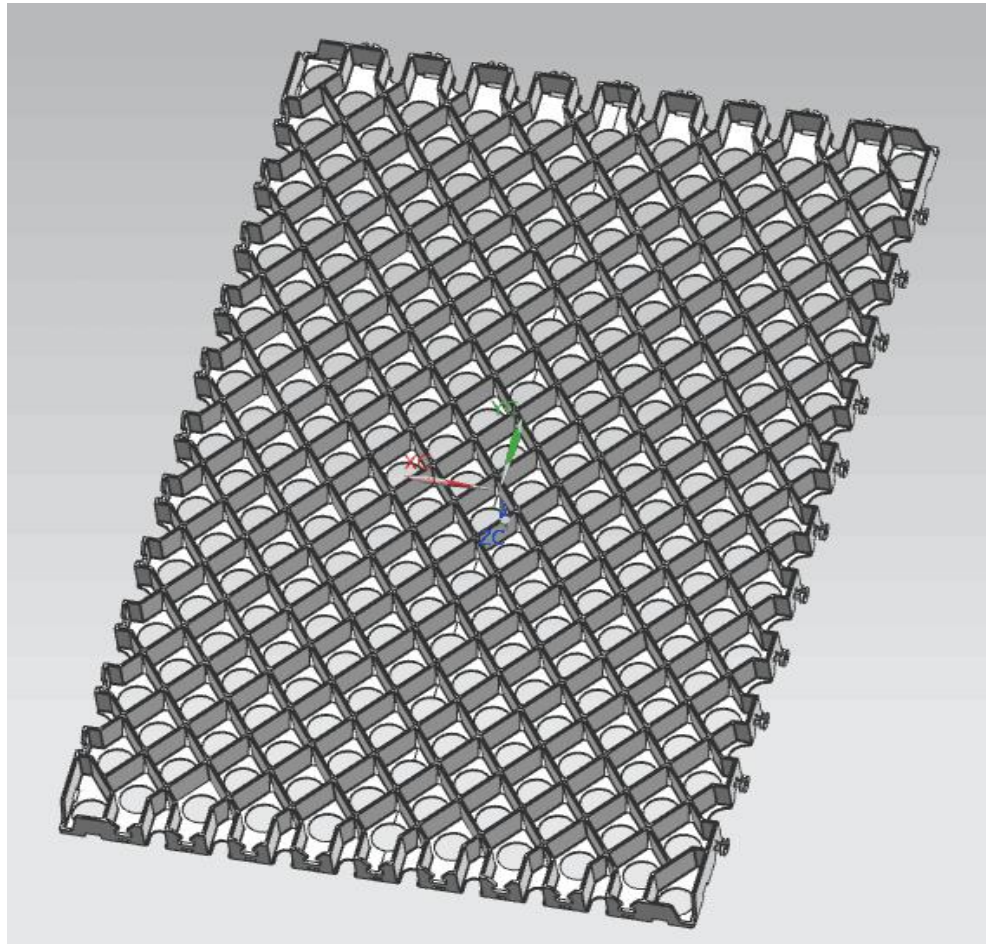

**Our existing sizes:**

1. 500x500x40mm
2. 1000x1000x40mm

We can custom your request sizes if necessary.



# Longxiang Group Ltd.

## Installation Guides

123 Grid' s easy locking system is simple to install and can be moved if you decide to re-locate your shed. The plastic pavers interlock and be configured to create a floor for any shed – no matter the shape or size. Relatively lightweight and easy to move, installation is simply a matter of laying the pavers down over levelled ground. A layer of gravel is then spread over the top; the grid design ensures the gravel is contained, meaning your floor remains flat and even. And if you decide to re-locate or extend your shed? Unlike concrete that is only suited to single-use, our pavers can be easily removed or added to if necessary.







# Longxiang Group Ltd.

## Applications

Our classic grid size is suitable for most rural and domestic applications. Great for smaller surface areas that require stabilisation and reinforcement. Highly recommended for feed & water troughs, stable floors, muddy areas, day yards, pathways, drains, driveways, golf cart tracks, boat ramps and anywhere needing toughening up on your property or workplace.

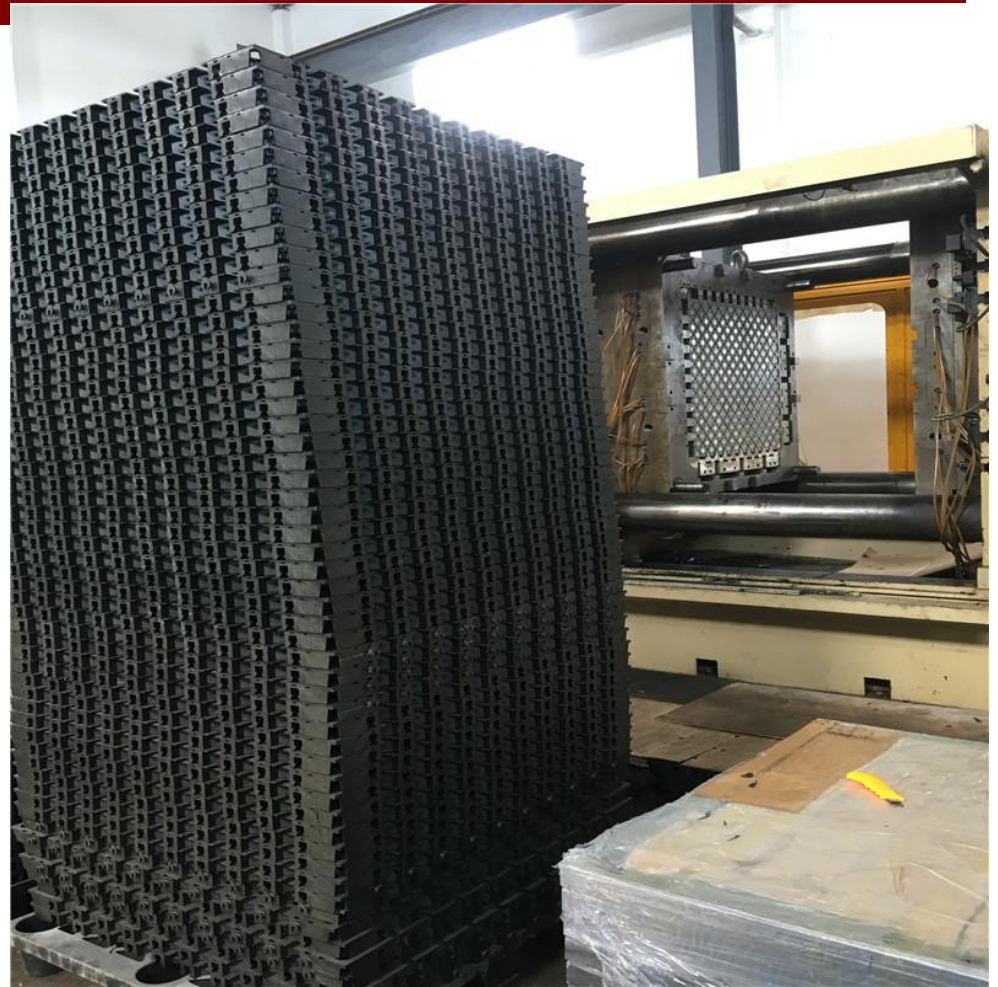



Longxiang Group Ltd.

Over 100tons loading



2018-03-28

123 Plastic Grids



Longxiang Group Ltd.

## DRIVEWAY

The unique design of 123 Grid allows you to build attractive driveways with decorative pebbles by stabilising the fill so that it does not migrate, even in areas subject to constant traffic or repeat wheel tracking and turning. The product is also effective in ensuring that different fills do not mix together, erode or wash away. 123 Grid is easily laid without framework and the grids do not crack or separate over time like concrete, bitumen or paving.





Longxiang Group Ltd.

## FEED & WATER TROUGHS

The areas around water and feed troughs are always wet and muddy and 123 Grid solves the problem by creating a well-drained solid surface for both horse and human. The grids also allow the animals to easily eat any spilt feed. 123 Grid is great for:

- protecting ground against erosion;
- improving drainage; and
- reinforcing surfaces to ensure durability against heavy loads and constant use.

123 Grid can be easily installed with grass, gravel or road base filling to form a surface that is water permeable.





Longxiang Group Ltd.

## MINE ACCESS ROADS



123 Grid eliminates the ongoing expense of road maintenance crews and machinery and provide a safe and durable surface.



Longxiang Group Ltd.

## CAR PARKS



123 Grid allows you to build car parks that are attractive, environmentally friendly, economical and can withstand use in areas with high traffic and heavy loads. Grids are easily laid without framework and do not crack or separate like concrete or paving over time. Rather than setting up drainage areas around the grids, all water drains directly through them.



Longxiang Group Ltd.

## ARENAS



123 Grid introduces a new generation in all weather arena surfaces. Effective even in intrepid weather conditions, Diamond Grid offers a stable and long lasting equine exercise surface.



Longxiang Group Ltd.

## HORSE STABLE FLOORING SOLUTION



2018-03-28

123 Plastic Grids





Longxiang Group Ltd.

## GOLF COURSES



123 Grid is perfect for stabilizing golf cart tracks and pathways, protecting them from becoming boggy, or being eroded away.



Longxiang Group Ltd.

## HAUL ROADS

123 Grid can be used as a top surface on haul roads to prevent pot holes, corrugation and erosion on road edges. The grids reduce downtime, and help reduce labour and machinery costs compared to using concrete. They also reduce the costs of running a grader to repair roads.





Longxiang Group Ltd.

## MUDDY AREAS

123 Grid is perfect for those permanently boggy areas such as day yards, wash areas, gate entrances, vehicle paths and muddy areas around water troughs.





Longxiang Group Ltd.

123 Grid can be used to create a solid surface for hardstands without the costs associated with common sealing products such as concrete and bitumen



2018-03-28

123 Plastic Grids



Longxiang Group Ltd.



## **BITUMEN REINFORCEMENT**

The 123 Grids are filled with 5-15mm of gravel and then bitumen emulsion is poured over the top. This method is cheaper than traditional bitumen installation and will last longer.



Longxiang Group Ltd.

## Planting grass

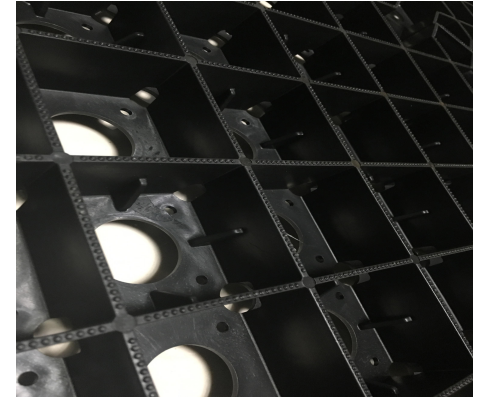

2018-03-28

123 Plastic Grids



## Packing Details

Model	Material	L (mm)	W (mm)	H (mm)	Thickness (mm)	Weight (kg)	20'ft (m2)	40HQ (m2)
50050040	PP	500	500	40	3.2	1.1	500	1210
1000100040	PP	1000	1000	40	3.2	5.6	500	1210

## Delivery Time

- ◆ Quantity at 500-1000sqm, can be delivered within 7 -10daysdays;
- ◆ Quantity at1000-3000sqm, can be delivered within 15-20days;



# Longxiang Group Ltd.

---

## Contact Us

TEL: +86-20-29869896  
FAX: +86-20-39133893  
CELL: +86-135-70392519  
EMAIL: [sales4@longxiang-ltd.com](mailto:sales4@longxiang-ltd.com)  
SKYPE: milan-longxiang  
WEBSITE: [www.longxiang-ltd.com](http://www.longxiang-ltd.com)  
ADDRESS: No.96-1 Qixin Road,  
Dongchong Town, Nansha District,  
Guangzhou, 511453, China

